

10,7 UNIDADES DE LAMA POR CADA METRO LINEAL

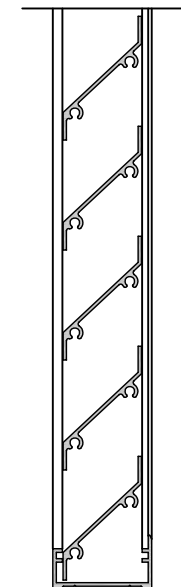

CON PIEZA DE SOPORTE **5058**

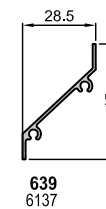
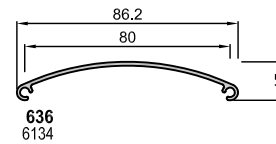
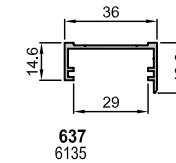
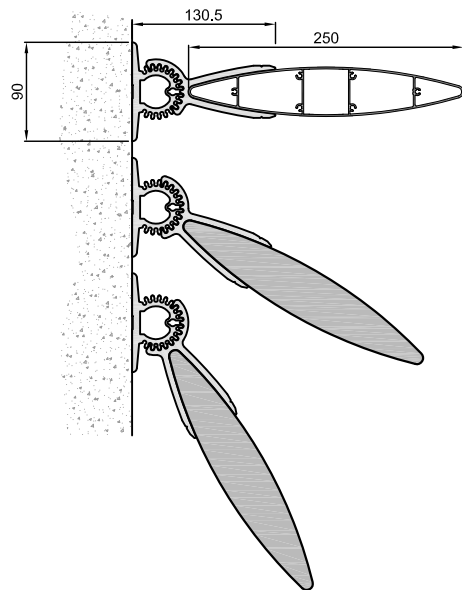
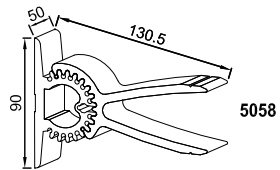
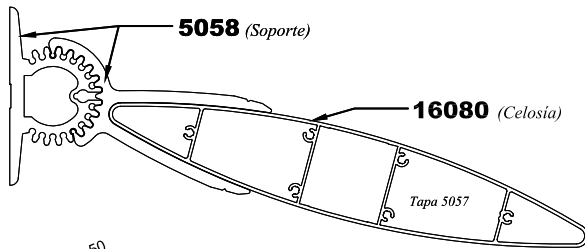

CON PIEZA DE SOPORTE **5061** (PARA CELOSIA DE 250 Y 200 mm), Y SOPORTE **5060** (PARA CELOSIA DE 120 mm.)

